

AS/NZS 3845.2 Certification

Our Advanced Polymer and Impact Recovery and Impact Absorbing Bollards are designed to comply with Australian Standard AS/NZ 385.2 to ensure they are crashworthy when impacted by a passenger vehicle.

All bollards have an element of risk and whilst many prefer bollards with greater energy absorption capabilities, product developers often choose a balance between containment capacity, energy absorption and practicality, realising that higher containment will cost more, and greater energy absorption will often require a more complex and less practical system.

Bollard selection requires an understanding of the bollard benefits/limitations and the site conditions, noting that modern vehicles are designed with multiple crashworthy systems, such as airbags, seat belt pretensioners and crumple zones, that can tolerate impact speeds up to 50km/h. As such, a generic bollard (set in an appropriate foundation) with no energy dissipation characteristics could pass some crash test requirements.

Acknowledging that the majority of vehicles can manage energy transfer during a head-on low speed impact (<50km/h), it is critical that bollards can prove a maximum level of containment and ensure that when they are impacted, they do not penetrate or show potential to penetrate the occupant compartment or present an undue hazard to other traffic, pedestrians or personnel in a work zone.

Likewise, the collision with a bollard should not cause the vehicle to excessively roll or pitch in order to provide the driver every opportunity to regain control of their vehicle. Tested products, with a known performance level and behaviour, must be used, especially where vulnerable road users are being protected.

We have a range of impact bollards to suit different purposes

- 1) Advanced Polymer Bollards are impact resistant
- 2) Impact Recovery Bollards self-recover from impact
- 3) Impact Absorbing Bollards stop a vehicle

Category	Testing	Objective
Road Safety Device	Compliant crash testing to AS/NZS 3845.2:2017.	Used to shield hazards and/or other roadside features from an errant vehicle
Protection Device	Compliant or Modified crash testing based on AS/NZS 3845.2:2017. (may not comply with occupant injury criteria)	Used to protect pedestrians or high-severity hazards from errant vehicles in low-speed environments.
Roadside Furniture	Non-compliant testing, engineering analysis or not tested.	Used for delineation, physical obstruction or minor asset protection in product suitable locations.
Vehicle Security Barrier	Compliant crash testing for 'Hostile Vehicle' purposes - IWA14-1: Vehicle security barriers. Impact severity for errant vehicles to be minimised through design.	Used to stop a hostile vehicle attack in accordance with IWA 14-2 and relevant guidelines. Impact likelihood and severity for errant vehicles to be minimised via speed and location or roadside protection.

Overview

Advanced Polymer Bollards were crash tested in accordance with AS/NZS 3845.2 demonstrating crash worthiness for speed zones up to and including **10 km/hr** and were evaluated for structural adequacy, occupant risk and vehicular trajectory.

Advanced Polymer Bollards meet AS3845:2 Standard to Test Level 0:1600kgcar >10km/hr.

Impact Recovery Bollards were crash tested in accordance with AS/NZS 3845.2 demonstrating crash worthiness for speed zones up to and including **10 km/hr** and were evaluated for structural adequacy, occupant risk and vehicular trajectory.

Impact Recovery Bollards meet AS3845:2 Standard to Test Level 0:1600kgcar > 10km/hr.

Energy Absorbing Bollards considered a "protection device", were crash tested in accordance with AS/NZS 3845.2 demonstrating crash worthiness for speed zones up to and including **60 km/hr** and were evaluated for structural adequacy, occupant risk and vehicular trajectory.

Energy Absorbing Bollard (EAB) has been recognised for meeting AS3845:1999 Standard to Test Level 0:1600kgcar at 60km/hr.

Energy Absorbing Bollard (EAB) has been crash tested in accordance with AS3845.2 demonstrating they can contain a 1,600kg vehicle at 51.9km/h with an Impact Energy of 166.3kJ when installed in soil, test no. 21062-01.

Another test conducted with a Concrete slab at the surface showed they can contain a 1,615kg vehicle at 62.5km/h with an Impact Energy of 243.4kJ, test no. 21062-02.

Impact energy containment

Meeting your requirements: **New, modified or replacement bollards shall be designed and installed such they can contain a minimum impact energy of 156.4kJ and be in accordance with AS/NZS 3845.2**

When a bollard is impacted the energy has to go somewhere, something's got to give, so unless you incorporate some form of shock absorbing mechanism, either the bollard is damaged or the footing.

If a rigid steel bollard is impacted it is generally the footing that is dislodged, and with no energy absorption mechanism, the impact force acting upon the vehicle occupants at just 50 km/hour it is equivalent to being rammed by a 3.5 tonne elephant.



Alternatively an Advanced Polymer Bollard when impacted by a vehicle has the ability to elongate 100% before being and not recovering- this reduces the impact force and the risk of damage to the footings causing dangerous debris and trip factors. An Advanced Polymer Bollard installed directly in a concrete footing, when impacted will initially deform to absorb the impact force and if the flexural modulus (around 25 degrees) is exceeded the bollard will bend and not recover.

- If impacted at low speed (10 kmph) the vehicle will “bounce” off the bollard.
- If impacted at high speed (60 kmph) the bollard will bend at ground level and not recover.

The outcome: as opposed to a steel bollard that would uproot the concrete footing and surrounding foundations, is that an Advanced Polymer bollard will remain planted in the concrete and will bend a maximum of 80 degrees from upright, remaining planted in the concrete footing.

Speed and vehicle mass form a critical area when assessing the type of bollard and its corresponding footing to install. The transfer of force in the form of kinetic energy (KE) when a vehicle engages with a bollard is a key determinant dictating the type, size, wall thickness and footing design of any proposed bollard, with the most important factor being the depth and strength of the footing.

Improving resistance

The second most important consideration is the size and quality of the footing. If you want to prevent a footing from being damaged reinforcing the footing with a reo cage increases resistance against damage and dislodgement saving time and money.

We have a range of options for overcoming the problem of damage and costly repairs.

- Making Bollards Impact resistant
- Making footings Impact resistant

You need to determine what is the desired outcome

- Protecting people and assets
 - Reducing damage and waste
 - Improving safety and efficiency
-

Your Options:

- 1) If you require a bollard to prevent access and be low cost to purchase (easy to install as lightweight) and low cost to maintain - we recommend the Advanced Polymer Bollards.
- 2) If you require a bollard to prevent access and be extremely low cost to install and extremely easy to maintain and improving safety – reducing waste to zero we recommend the Impact Recovery Bollards.
- 3) If you wish to further reduce maintenance on the Impact recovery Bollards (and they may be subject to impact from heavy vehicles) we suggest using 650 mm footings and reinforcing the footings using a reo cage
- 4) If you require a bollard to stop a passenger vehicle in its tracks, you require Energy Absorbing Bollards. Although they cost more to maintain they provide greater protection against errant vehicles.

Advanced Polymer Bollard

Advanced Polymer Bollards were crash tested in accordance with AS/NZS 3845.2 demonstrating crash worthiness for speed zones up to and including **10 km/hr**

Bollard:

150 mm diameter
Advanced Polymer
7mm wall thickness
1200 mm high

Footing:

Installed in solid asphalt.
300 mm width concrete footing
400 mm below ground

Vehicle

Passenger vehicle weighing 1600kg.
Impact Speed 10km/hr

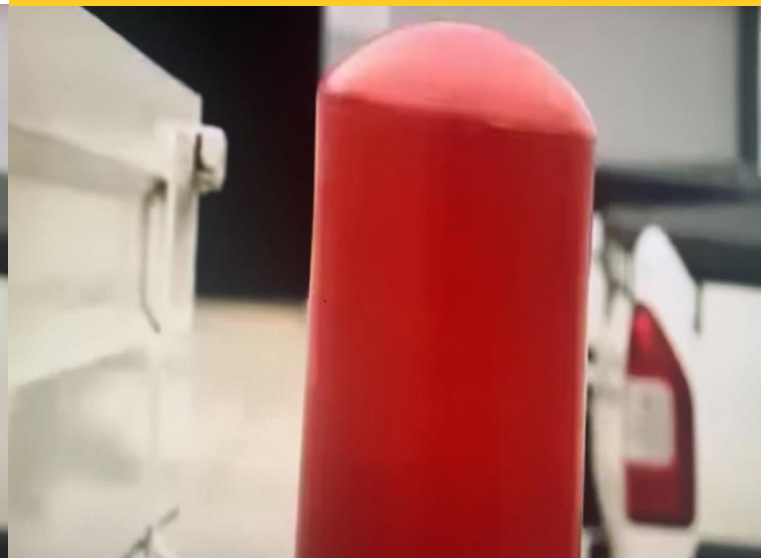

Outcome: Bollards deflected and self-recovered following multiple impacts at low speed demonstrating no reduction in capacity to recover. Bollard was not impacted at high speed. Bollards in situ have been impacted at high-speed resulting in the bollard bending approx. 80 degrees and the footing requiring replacement.

The “elastic” nature of the bollards results in vehicles “bouncing” off the bollard without damage to either the vehicle or bollard.

[VIEW VIDEO](#)



Impact Recovery Bollards

Advanced Polymer Bollards were crash tested in accordance with AS/NZS 3845.2 demonstrating crash worthiness for speed zones up to and including **10 km/hr**

Bollard:

165 mm diameter Steel
5 mm wall thickness
800 mm height

Footing:

Installed in solid asphalt.
300 mm width concrete footing
350 mm below ground

Vehicle

Passenger vehicle weighing 1600kg.
Impact Speed 10km/hr

OPTIONS

By installing a reinforcing reo cage on 650 mm footings you can install a 5mm resistance core, reducing the incidence of the core bending upon high impact.



Outcome: Bollards deflected and self-recovered following multiple impacts at low speed demonstrating no reduction in capacity to recover. At low speed the bollard deflected up to 20 degrees at which time the driver was aware of hitting the bollard and reversed off- allowing the bollard to self-correct.

The “impact absorbing” nature of the bollards results in vehicles “bouncing” off the bollard without damage to either the vehicle or bollard.

[VIEW VIDEO](#)



Impact Absorbing Bollards

Impact Absorbing Bollard, were crash tested in accordance with AS/NZS 3845.2 demonstrating crash worthiness for speed zones up to and including **60 km/hr**

Bollard:

150 mm diameter Steel
1450 mm Length
Weight 67.5 kg

Footing:

Installed in solid asphalt.
700 mm width concrete footing
1000 mm below ground
Reinforced using reo cage

Vehicle

Passenger vehicle weighing 1600kg.
Impact Speed 60km/hr

OPTIONS

By increasing the depth of the footing with a reinforcing reo cage bollards can control errant vehicles weighing up to 2270kg



Outcome: Bollards deflected to a maximum of 45 degrees upon impact demonstrating they were capable of preventing an errant vehicle from entering an area. The impact absorbing cushion crushed and required replacing. Meets Australian Crash Barrier Standard AS/NZS 3845:1999 (60 km/h).

The “impact absorbing” nature of the bollards results in vehicles being brought to a complete stop, protecting people and assets from errant vehicles

[VIEW VIDEO](#)



Table of Contents

Overview	2
Improving resistance.....	3
Advanced Polymer Bollard.....	5
Impact Recovery Bollards.....	6
Impact Absorbing Bollards.....	7
Advanced Polymer Bollard	10
Materials.....	11
Sun Resistance:.....	13
What is UV Stabilisation?.....	13
VP319	14
Testing UV Protection Levels in Polyethylene	14
High impact resistant plastics	14
Heavy Duty Design.....	14
Looking good is also important to us!.....	15
Bollards remain secure in footing	15
Impact Recovery Bollards	16
Meeting market requirements.....	20
Containment.....	21
Impact Recovery Bollards Tested from 0-10 kmph	22
Impact Recovery bollards.....	23
Protection Device.....	24
Footings Tested from 10 – 110 kmph	25
Upon high impact.....	26
Deflection Zone	27
Improved safety.....	28
Improved workplace safety	29
Replacing a damaged Bollard	30
Safe working procedures.....	31
Reducing risk of litigation.....	32
Containment Level.....	33
Locally manufactured	34
Emergency Access.....	34
End of life	34

Environment	35
Design criteria.....	37
Proactive performance	39
Installation IR Bollards.....	41
Depth Footing Required.....	42
Increasing resistance.....	43
Reinforcing Footing.....	44
Installing ZERO WASTE foundations.....	45
Installing ground sockets	46
Installing Bollards.....	47
Replacing Bollards	48
Replacement components	49
Safe working procedures.....	50
Impact/ Energy Absorbing Bollards	52
Two Options	54
Specs.....	55
Repair and maintenance	56

Advanced Polymer Bollard

Advanced Polymer Bollards were crash tested in accordance with AS/NZS 3845.2 demonstrating crash worthiness for speed zones up to and including **10 km/hr**

Bollard:

150 mm diameter
Advanced Polymer
7mm wall thickness
1200 mm high

Footing:

Installed in solid asphalt.
300 mm width concrete footing
400 mm below ground

Vehicle

Passenger vehicle weighing 1600kg.
Impact Speed 10km/hr

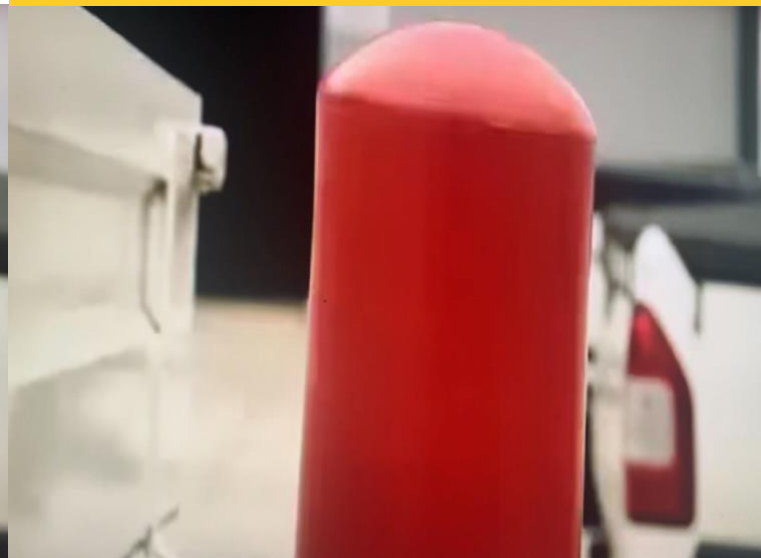

Outcome: Bollards deflected and self-recovered following multiple impacts at low speed demonstrating no reduction in capacity to recover. Bollard was not impacted at high speed. Bollards in situ have been impacted at high-speed resulting in damage to the bollard bending and footing requiring replacement.

The “elastic” nature of the bollards results in vehicles “bouncing” off the bollard without damage to either the vehicle or bollard.

[VIEW VIDEO](#)



Range of options

150 mm Standard units are Safety Yellow (with optional Red / White reflective striping).

Available in almost any colour (ask for a colour chart) and can be polished for high shine. Moulded dome cap



INGROUND

Bollards can be installed directly inground absorbing vehicle impact and recovering

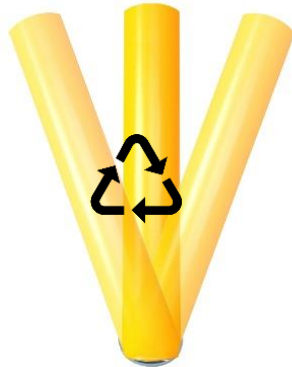

SURFACE MOUNT IR

Bollards can be surface Mounted using the Impact Recovery System deflecting >20 degrees and recovering



INGROUND IR

Ca be secured inground using the Impact Recovery System deflecting >20 degrees and recovering.

Advanced Polymer Bollard

- Lengths available 1250/ 1500/1800L
- 150 mm Diameter
- Std units Safety yellow
- Can be made other colours (Min 10)
- Reflective striping available (Red/white)
- Smooth Finish
- Dome cap

Impact Recovery System

Saving thousands over the lifespan of a development making bollards removable and reusable following impact.

- Surface Mount or inground foundation
- 3.6 or 5 mm Resistance Core
- 2 x Impact Recovery Rings

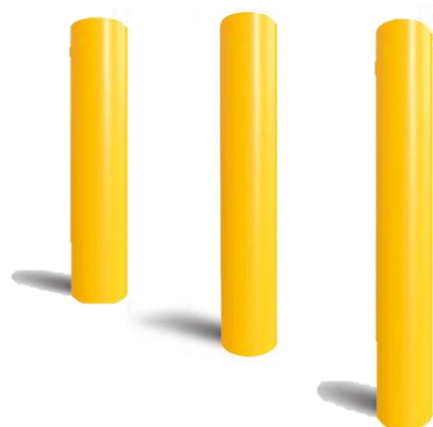

Materials

Unlike most imported plastic Bollards with thin 1-3 mm wall thickness, Advanced Polymer Bollards are roto moulded from a solid piece of Advanced Polymer material, with heavy duty 7 mm walls which ensures that they are structurally sound and robust enough to withstand light impact from a vehicle and self-recover.

Polyethylene and polypropylene are frequently used in construction, military and industrial applications that require impact resistance and toughness. Impact resistance is the ability of a material to resist both fracture and deformation when temporary force is applied.



STEEL BOLLARD

150/165 mm \varnothing Galvanised steel bollards have an average design life of around 30 years.

POWDER COATING

Helps prevent corrosion of the steel part and extend the life of components used outdoors with a lifespan of 15-20 years in direct sunlight

ADVANCED POLYMER

Advanced Polymer Bollard Cover 190 mm \varnothing x 1200 H in Safety Yellow has a design life of around 50 years (25 years in direct sunlight).

NB: As steel is the most common material used for bollards we have made a comparison with steel bollards. The design life of steel when installed directly in concrete can be reduced considerably due to the corrosive nature of concrete when acting upon steel. The design life of Advanced Polymer bollards is far superior to steel. Not only is the material more resilient to environmental conditions it is more resilient to impact, denting and scratching. Steel when installed directly in concrete can be reduced considerably due to the corrosive nature of concrete when acting upon steel.

SPECS

- Tensile strength at 72°F: 1,400 psi
- Tensile modulus: 57,000
- Tensile elongation at break: 100%
- Flexural modulus: 29,000 psi

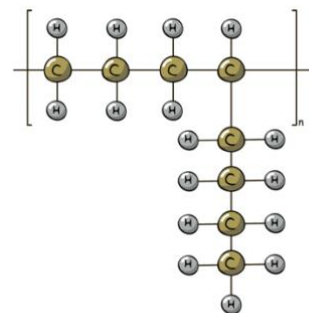

Advanced Polymer

Our Advanced Polymer is highly durable material designed to withstand impact and the harsh Australian sun and is an efficient electrical insulator, making it great for applications where safety is paramount. We use a hexene copolymer based linear medium density polyethylene with a base resin VP319 polymer containing a long-term UV stabilisation package greater than UV8 providing excellent impact resistance, light weight, and high tensile strength. An in-house QA system is in place to provide reliability and continuity of supply.

Benefits

Abrasion Resistant
High impact resistance
Low coefficient of friction
Abrasion resistant
Scratch and marking resistant
Chemical resistant
Water and moisture resistant
UV Resistant
Shatter resistant
Long-wearing
Corrosion resistant
Strength tested to AS/NZS 4766:2006
UV20 Protection to ASTM D2565
Australian Made

Re-usable

Unlike steel that will distort when impacted, Advanced Polymer Bollards flex under extreme conditions and recover. If scratched, they are the same colour throughout and when scuffed by vehicle tyres, they can simply be wiped clean. They self-recover from light impact, or when installed using the ZERO WASTE Impact Recovery System they become re-usable following even the most severe impact.

Sun Resistance:

Polyethylene (poly) Bollard Covers are made of a plastic material. Many have seen the effects on plastic objects that are exposed to the harmful UV-rays of our Sun. Over time, they become brittle, chalk and crack as the polymer elongation drops, that is, the structural integrity of plastic.

The natural conclusion is that poly Bollards won't last long in the Sun. This is just not true, especially not with our Advanced Polymer Bollard Covers which are made from a blend of HDPE, Ultra-Violet Stabilization and VP319 Resin our Advanced Polymer Bollards and Bollard Covers have more than 4.5 times the UV8 protection required by the Australian standard (AS/NZ 4766:2006).

What is UV Stabilisation?

Many metals will rust and corrode as they weather and wither away. Steel, however, can be strengthened against oxidation when chromium is added or protected from rust and oxidation using galvanising. There are different grades of stainless steel. Kitchen sinks, for example, are often made of a high-grade of stainless steel.

Similarly, UV stabilisers are to bollards like what the chromium is to steel. When added to the polymer mix, the plastic is protected against becoming brittle in the Sun. UV stabilizers in the polymer protect the Bollard against the harmful UV rays, preventing it from bulging, warping, or going brittle over time, inhibiting and absorbing the harmful UV light that causes it break down.

So, in the same way that some steels are called stainless, you could similarly label UV stabilised poly a type of “stainless poly”. Of course, all material has a finite life. Stainless steel will still rust and corrode, it just takes much longer for this to happen.

VP319

Australia experiences some of the highest levels of UV radiation in the world. As such, leading edge technology is required to ensure our bollards remain reliable and durable for a long time. UV8 level of stabilisation has been considered the minimum required for good long-term protection in Australia. Our UV stabilisation package provides a much higher level of protection than the Australian industry standard (AS/NZ 4766:2006).

Through careful selection of a high-quality Polyethylene base polymer specifically designed for tank use, advanced additives such as UV stabilisers and antioxidants, pigmented “SUPA UV” provides a UV36 level of stabilisation.

Testing UV Protection Levels in Polyethylene

UV protection levels in polyethylene are assessed under highly controlled conditions of high intensity UV radiation with similar wavelengths to those from the Sun. Samples are removed from the UV weatherometer every few thousand hours and stretched in a tensile tester to determine how much they can still stretch.

This provides the % Elongation of the test sample. This value is compared to the value obtained for the set that was not placed in the weatherometer and recorded on a graph as the % Retained Elongation. The % Retained Elongation decreases as degradation increases. Once the Elongation drops to 50% the poly sample is deemed to have failed. After 36,000 hours of accelerated UV weathering, pigmented samples retained well over 50% of their original elongation properties.

High impact resistant plastics

Plastic materials are frequently used in construction, military and industrial applications that require impact resistance and toughness. As implied by the name, impact resistance is the ability of a material to resist both fracture and deformation when temporary force is applied.

Unlike steel Bollards (and most imported plastic Bollards on the market made from old fashioned plastics that often exhibit values under 5%, over time fade and become brittle), Advanced Polymer Bollards have unique properties and benefits that allow them to perform in demanding environments, demonstrating tensile elongation at break: 100%.

Whilst the impact resistance of a plastic is temperature-dependent (becoming brittle below 15° , LMDPE retains its properties in even low temperatures.

Heavy Duty Design

Unlike most plastic Bollards on the market with thin 1-3 mm wall thickness, our Bollards and Bollard Covers are rotomoulded from a solid piece of Advanced Polymer material, with heavy duty 7 mm walls which ensures that they are structurally sound and robust enough to withstand even the hottest summer sun.

Looking good is also important to us!

Solid 7 mm walls ensure our Bollards remain looking good impact after impact. Made using a durable, versatile thermoplastic that offers fantastic impact resistance and tensile strength. Since its molecules are packed together so tightly, this material boasts incredible toughness and rigidity combined with the ability to absorb impact force.

Unlike steel that will distort when impacted, our Poly Bollard Covers will flex under extreme conditions and recover. If scratched, they are the same colour throughout and when scuffed by vehicle tyres, they can simply be wiped clean. We can even self-recover from light impact, or (when installed using the ZERO WASTE Impact Recovery System) we become re-usable following even the most severe impact.

Bollards made from steel or concrete are strong but they are not scratch, dent, rust or impact resistant, creating a costly never ending cycle of damage and waste as both the bollard and costly footings require repeated replacement over the life of a development, often having a devastating effect on the surrounding pavement.

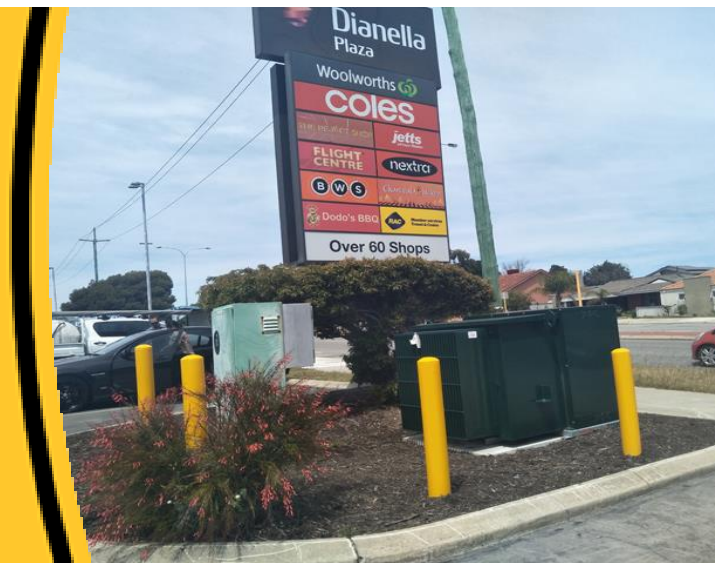

They are also downright treacherous to vehicles- we have a solution that makes them safer and far more resilient, making both the bollard and expensive concrete footings re-usable impact after impact. If scuffed by vehicle tyres bollards can be simply wiped clean. No need for painting or replacing.

Bollards remain secure in footing

As opposed to a steel bollard that would uproot the concrete footing and surrounding foundations, is that an Advanced Polymer bollard will remain planted in the concrete and will remain planted in the concrete footing, bending a maximum of 80 degrees from upright.

The Advanced Polymer Bollard has a lip of around 7- 8 mm that protrudes from the base of the bollard, to secure it in the concrete footing and ensure the bollard cannot be lifted from the concrete footing.

The fact that the bollard “folds” and yet remains planted in the concrete footing ensures bollards do not become dangerous projectiles.

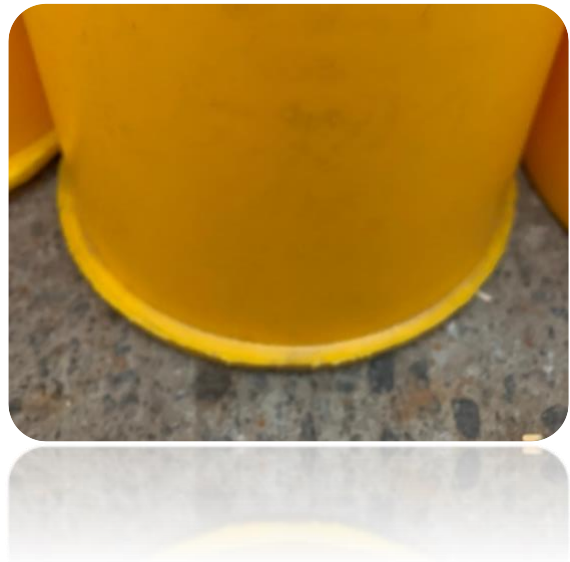

Impact Recovery Bollards

Advanced Polymer Bollards were crash tested in accordance with AS/NZS 3845.2 demonstrating crash worthiness for speed zones up to and including **10 km/hr**

Bollard:

165 mm diameter Steel
5 mm wall thickness
800 mm height

Footing:

Installed in solid asphalt.
300 mm width concrete footing
350 mm below ground

Vehicle

Passenger vehicle weighing 1600kg.
Impact Speed 10km/hr

OPTIONS

By installing a reinforcing reo cage on 650 mm footings you can install a 5mm resistance core, reducing the incidence of the core bending upon high impact.



Outcome: Bollards deflected and self-recovered following multiple impacts at low speed demonstrating no reduction in capacity to recover. At low speed the bollard deflected up to 20 degrees at which time the driver was aware of hitting the bollard and reversed off- allowing the bollard to self-correct.

The “impact absorbing” nature of the bollards results in vehicles “bouncing” off the bollard without damage to either the vehicle or bollard.

[VIEW VIDEO](#)





05

The most environmentally sound plastic available today, (no.5 Plastic) has been used to design the world's first sustainable foundations that continue working for the entire lifespan of a development.

Providing a simple solution to five major problems facing our industry today.

RAPID URBANISATION AND GROWING WORKLOAD



GROWING DIFFICULTY PERFORMING THIS WORK



GROWING RISK OF LITIGATION



GROWING COSTS



CARBON CONSUMPTION & CARBON WASTE



Advanced engineering overcomes these problems



Bollards self-recover

Upon low-speed impact bollards absorb the impact force and slowly self-recover and are removable and reusable following severe impact



No damage to footings

ZERO WASTE Foundations remain in pristine condition for the entire lifespan of a development and base plates are reusable following severe impact.



Bollards Impact Resistant

ZERO Bollards are made from Australian heavy-duty materials designed to withstand impact without damage, remaining in good condition.



Bollard re-usable

Both surface mount and Inground bollards are made removable and reusable following severe impact, saving thousands over the life of a development.



Footings reusable

ZERO WASTE foundations remain in pristine condition and surface mount base plates are reusable following severe impact, saving thousands.



Simple replacements

Bollards are low cost to maintain. If damaged, they are removed and replaced in less than 5 minutes without the need for digging or heavy labour.



Impact resistant base plate

With square base plates the impact force is concentrated on one anchor- with heavy duty round base plates the impact force is evenly distributed, reducing the risk of damage.



Superior protection

Unlike flexible bollards that can over-flex, becoming increasingly weak over time, the strong resistance core provides superior protection against errant vehicles, greatly improving safety.



Advanced Polymer Bollard

Unlike cheap imported plastic bollards. Advanced polymer bollards (and bollards covers) provide excellent resistance against denting, chipping and fading- extending the potential lifespan.

Meeting market requirements

Developed in response to a request from Main Roads for a means of preserving concrete footings when items are impacted, and a request from City of Perth for a means of preventing access whilst also preserving the foundations, making bollards easily replaceable when impacted and low cost to maintain.

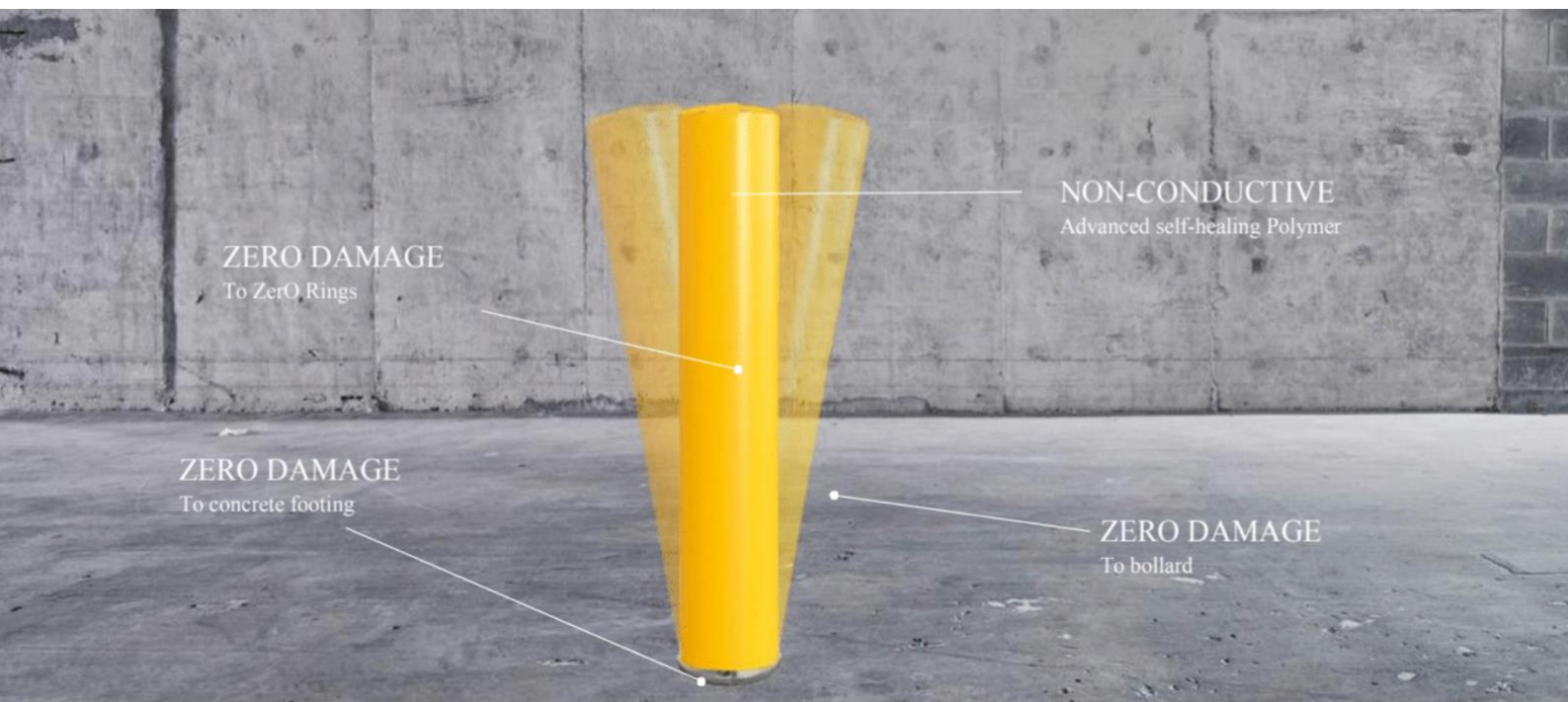

City of Perth had a problem maintaining bollards in the busy city centre. They came to us to develop a solution that would provide protection for café strips and pedestrians, reduce damage to vehicles and reduce the escalating cost of maintaining their bollards. We developed the Impact Recovery System that provides a low cost and sustainable solution to all of these problems.

Containment

Tests used 3.6 resistance core 300 mm Height. Bollards were impacted at 10 kmph in test situation to replicate impact in a carpark. In situ bollard have been impacted up to 60 km/hr.

At low speed the bollard deflects up to 20 degrees at which time the driver was aware of hitting the bollard and reversed off- allowing the bollard to self-correct. At high speed the internal resistance core bent at ground level and needed replacing.

Result of multiple impacts:

Bollard did not penetrate or show potential to penetrate the occupant compartment or present an undue hazard to other traffic, pedestrians or personnel in a work zone (e.g. Zero disturbance to footing resulting in zero debris)



Tests used 3.6 resistance core 300 mm Height. Bollards were impacted at 10 kmph in test situation to replicate impact in a carpark. In situ bollard have been impacted up to 60 km/hr.

At low speed the bollard deflects up to 20 degrees at which time the driver was aware of hitting the bollard and reversed off- allowing the bollard to self-correct. At high speed the internal resistance core bent at ground level and needed replacing.

Impact Recovery Bollards Tested from 0-10 kmph

Impact Recovery Bollards have been tested for use in car parks up to 10km/hr, demonstrating no reduction in ability to recover following multiple impacts.

BOTH LABORATORY AND INSITU IMPACT TESTED AT 0-10 KMPH

IRS ABSORBS IMPACT FORCE

The Impact Recovery System protects foundations from damage by absorbing the impact force making it possible to install bollards in relatively shallow footings and even surface mount bollards.

BOLLARDS RE-USABLE

Steel bollards can be damaged upon impact (scratched or dented) but stainless steel and Advanced Polymer are more resilient, able to withstand impacts without any major damage, and can be reinstated impact after impact

ZERO DAMAGE TO RINGS

Rings are made from a highly durable advanced polymer composite that withstands hundreds of impacts without any reduction in its ability to recover. Consequently, rings are reusable year after year.

Safe & Secure

Bollards remain rigid and appear to be solid inground bollards – they cannot be deflected by hand (like other flexible bollards), remaining perfectly aligned safe and secure year after year.

Upon Low Impact

When impacted by a vehicle they absorb the impact force deflecting a maximum of 20 degrees and self-recovering, with no diminished capacity following hundreds of impacts.

Severe Impact

When severely impacted the resistance core bends allowing the bollard to fold but not be dislodged- preventing any further forward movement of the vehicle and enabling fast reinstatement.

Impact Recovery bollards

For a bollard to be impact resistant the footing needs to be substantial and yet when impacted – something's got to give. The result is that thousands of bollards and concrete footings are repeatedly replaced and sent to landfill. Unless you incorporate some form of shock absorbing capabilities, the bollard and footing will need replacing every time.

S/MOUNT IRS

Suitable for solid concrete footpaths and foundations. Secured using five evenly spaced concrete anchors. Base is reusable.

350 DEPTH IRS

We recommend 400 mm depth footings for applications in solid concrete footing and asphalt.

650 DEPTH IRS

We recommend 650 mm depth footings for installation in sand; free standing footings and bollards subject to extreme impact.

We get knocked down, but we get up again. You're never going to keep us down!

Bollards cannot be deflected by hand, remaining perfectly aligned safe and secure year after year. When impacted by a vehicle they deflect to a maximum of 20 degrees and self-recover.

When severely impacted (truck or utility vehicle) the resistance core can bend and need replacing. Replacements take less than 5 minutes.

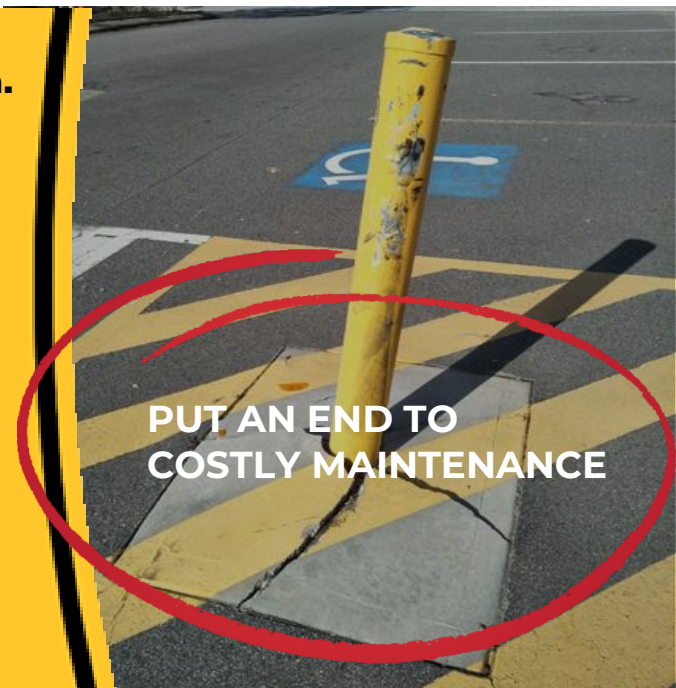

Upon Low Impact

Bollards remain rigid and appear to be solid inground bollards but when impacted by a vehicle they absorb the impact force deflecting a maximum of 20 degrees and self-recovering, with no diminished capacity following hundreds of impacts.

Severe Impact

When severely impacted instead of the entire footing being dislodged, the inner resistance core bends allowing the bollard to fold but not be dislodged- preventing any further forward movement of the vehicle and enabling fast reinstatement.

Fast efficient replacements

Replacements are simple Following severe impact bollard is easily removed (resistance core replaced) and reinstated in around 5 mins Bollards and ZerO Rings are re-usable impact after impact.

Protection Device

While these bollards cannot be considered a 'road safety device', they offer a proven containment level and may be suitable to protect pedestrians from errant vehicles in low-speed environments.

Smart Urban Impact Recovery Bollards incorporate a strong resistance core able to contain an errant vehicle, and because of the ability to absorb impact energy do not present an undue risk to vehicle occupants during impact.

Result of multiple impacts:

Bollard did not penetrate or show potential to penetrate the occupant compartment or present an undue hazard to other traffic, pedestrians or personnel in a work zone (e.g. Zero disturbance to footing resulting in zero debris)



Maximum containment level, being passenger vehicles travelling between 10 - 60km/hr the Impact Recovery System substantially reduces risk of injury to vehicle occupants due to its impact absorbing qualities.

Footings Tested from 10 – 110 kmph

Footings have been tested to withstand high speed impact and remain in tact, preserving valuable foundations for the entire lifespan of a development



BOTH LABORATORY AND INSITU IMPACT TESTED AT 10 - 110 KMPH

ZERO DAMAGE TO FOUNDATIONS

Zero damage to concrete footing or surrounding paving impact after impact for the entire lifespan of a development.

ZERO WASTE Foundations have no breakable components so continue working for the entire lifespan of a development.

ANY STRENGTH RESISTANCE CORE

Impact tests were performed on 2.3 / 2.9 / 3.6 / 5mm and solid rod. We suggest using a minimum of 3.6 mm wall thickness steel although if you are finding it is being damaged too frequently you can increase the core to 5 mm (increasing risk of damage to vehicles)

3.6 WALLED RESISTANCE CORE

3.6 steel resistance core x 300 mm height was impacted at 60 kmph bending upon impact from a passenger vehicle, (we suggest the core would damage the undercarriage of the vehicle) remaining firmly secured in the foundations.

No trip factors

Foundations remain in pristine condition following multiple impacts. No damage, no trip factors. If bollards are removed ground sockets can be capped.

Upon Low Impact

When Impact Recovery bollards are impacted by a vehicle at low speed the foundations remain intact, with no damage, requiring no costly repairs.

Severe Impact

When a bollard is severely impacted the foundations remain intact and are reusable following multiple impacts. No damage or waste, no disturbance.

Upon high impact

When an Impact Recovery System deflects beyond 20 degrees the internal resistance core may bend and require replacing.

A small passenger vehicle is unlikely to bend the core, but a utility vehicle or truck can bend the core upon high impact.

To reduce the incidence of the resistance core bending

and provide greater resistance against errant vehicles you can increase the strength of the resistance core to 5mm.

This requires a reinforced (reo cage) 650 mm – 1m concrete footing.



Following extreme impact, the resistance core will bend but bollards remain secure without debris or damage to surrounding foundations. To further reduce damage you can increase the strength of the resistance core.

Deflection Zone

Following multiple impacts ZERO Impact Recovery Bollards do not show potential to penetrate the occupant compartment or present an undue hazard to other traffic, pedestrians or personnel in a work zone.

The dynamic deflection is zero whereas the possible deflection zone is 80% the height of the bollard.

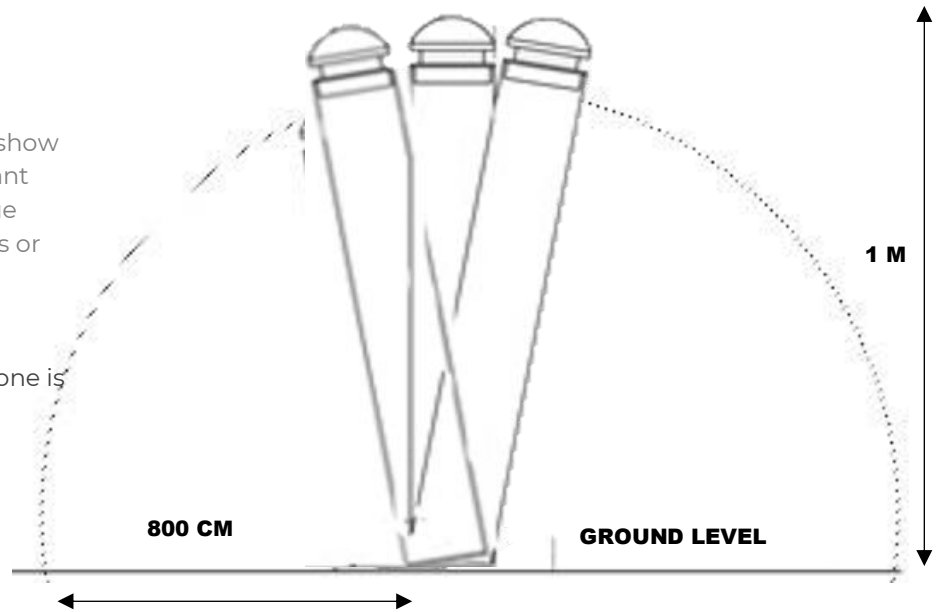

The Impact Recovery System provides a dynamic deflection zone of 20% for light impact and a maximum of around 80% of the height of the bollard upon severe impact.

IE: For a 1 m bollard the deflection zone is around 800 cm.



As shown above: When badly impacted the resistance core remains firmly secured in the ground socket and bollard will in most instances deflect a maximum of 30 degrees when badly impacted, although can deflect as much as 80 degrees if severely impacted by a truck or utility vehicle, remaining secured without debris or damage to surrounding foundations. By increasing the strength of the resistance core, you can reduce the risk of bending upon impact.

Improved safety

Bollards remain firmly secure, and are replaced quickly and efficiently using tools provided, presenting no undue hazard to other traffic, pedestrians or personnel in a work zone.

Bollards were traditionally designed to be rigid and unforgiving, but we soon realise that when impacted the force has to go somewhere! This design was without regard for driver or vehicle occupant safety. While this was unintentional, what this rigidity meant was that in a collision:

- There would be no redistribution of kinetic energy,
- The vehicle would stop more suddenly and potentially become airborne,
- The rigid body would transmit higher amounts of energy to its occupants, who would therefore undergo more forceful collisions with internal car structures and suffer greater damage to internal organs as a result.

One of the most effective innovations in automobile safety, the crumple zone is the area of a vehicle that is purposely designed to deform and crumple in a collision. The ability of a car to deform and redistribute the kinetic energy released on impact, saves countless lives every year.



Firstly, it redistributes the forces involved in a crash and secondly, it slows down the collision time, thereby decreasing the severity of injuries. The same applies to bollards- by incorporating a shock absorbing mechanism in the bollard you greatly reduce the risk of injury to drivers and vehicle occupants.

Improved workplace safety

Replacing damaged bollards is traditionally extremely heavy work involving hours of digging and heavy labour, often in dangerous working conditions. Rapid urbanisation is rapidly increasing the workload and difficulty performing this work.

- No.1 risk of injury to workers is body stressing resulting from digging and heavy labour,
- No1. Risk of serious injury is working in traffic,
- A third growing risk is injury resulting from hitting dangerous underground services.

Awarded Department of Occupational Health and Safety WorkSafe Award, Smart Urban has developed a simple means of overcoming all of the “above problems” by

100 %

REDUCE THE RISK OF INJURY CAUSED BY DIGGING & HEAVY LABOUR

100%

REDUCE THE RISK OF DAMAGE TO COSTLY UNDERGROUND SERVICES

100 %

ERADICATE THE NEED FOR COSTLY TRAFFIC MANAGEMENT

100%

REDUCE THE RISK OF WORKERS CONTRACTING DANGEROUS SILICOSIS



- 1) Reducing damage; and therefore workloads
- 2) Eradicating digging and heavy labour
- 3) Reducing time on location: Ergonomic tools enable all work to be conducted quickly and efficiently from a standing position without disturbance to foundations or traffic flow.

Replacing a damaged Bollard

If badly damaged the securing stud is removed, the bollard lifted off and the resistance core replaced. The bollard and the securing stud are then reinstated quickly and efficiently without disturbance.

An ergonomically designed removal tool is used to lever the resistance core from the ground socket and a “self-locking” taper is used to secure the resistance core in the socket. The resistance core is simply dropped into the ground socket “automatically” locking in tight and is only removable using the tool provided.



REMOVE STUD

Remove securing stud from bollard using Allen key (or security Allen key)



REMOVE BOLLARD

Slip bollard off



DROPPED INTO SOCKET

Resistance core is simply dropped into ground socket automatically locking in



REMOVAL TOOL

Place base up against post and apply quick jerking action to leverage arm, to release the lock and allow you to lift the resistance core from the ground socket.

WHAT'S THE CHAIN FOR?

If a bollard is severely impacted at high speed by a truck the resistance core can shear off (very rare- but if it does, you can still remove the core). The chain link is used to remove the core from the socket. The triangular head is place inside the post (and twisted until sharp edges grab onto internal walls of post) the chain is hooked over the pin on top of the tool and the tool is then used, as usual, to remove sheared off post from socket.

Safe working procedures

Tasks

Hazards

Safe working procedures

Precautions

<p>Installing Sockets</p>	<ul style="list-style-type: none"> - Bending of the back - Twisting of the back - Working in traffic 	<ul style="list-style-type: none"> • Dial before you dig • Install appropriate traffic management • Dig hole to insert ground socket • Insert Installation tool inside ground socket • Lower installation tool & socket into hole and fill with concrete. • Operate installation tool from standing position with straight back • Once concrete has cured spin tool to remove • Safely dispose of waste (recycle if possible) 	<ul style="list-style-type: none"> - Use installation tool to avoid bending of the back - When possible, it is advisable for user to face on-coming traffic - If item is not ready to install- insert cap to avoid tripping factors/ entry of dirt and grit - Insert cap before pouring asphalt to avoid trip factors/ ingress of asphalt
<p>Installing Items</p>	<ul style="list-style-type: none"> - Bending of the back - Twisting of the back - Working in traffic - Item not secure 	<ul style="list-style-type: none"> • Install appropriate traffic management • Attach Taper to item using self-drilling screws provided (This can be done prior to going onsite to reduce time on location) • Using two hands, drop item firmly into ground socket • Check item is sufficiently installed to protect from unauthorized removal 	<ul style="list-style-type: none"> - Avoid bending of the back - Avoid twisting of the back - When possible, it is advisable for user to face on-coming traffic - Make sure taper finishes flush with round level to provide adequate resistance against unauthorised removal
<p>Using Removal Tool</p>	<ul style="list-style-type: none"> - Bending of the back - Twisting of the back - Working in traffic - Trapping of fingers 	<ul style="list-style-type: none"> • Position a minimum of two safety cones or safety barriers at extremity of working space • Make sure the base of the tool as close as possible to the base of the item before applying jerking action • Apply quick jerking action using both arms • Lift item from ground socket using two arms (for items over 25 kg 2 people must lift item from ground socket) • Bend knees to insert cap in ground socket/ or insert new item 	<ul style="list-style-type: none"> - Always operate tool from a standing position facing tool - Keep back straight - Use quick jerking action as it requires less force - When carrying tool hold arms together with upright to avoid trapping fingers - When possible, it is advisable for user to face on-coming traffic

Reducing risk of litigation

At just 50 km/hour a person not wearing a seat belt that collides with a static steel bollard has the same experience as falling from a 3-story building or getting rammed by a 3.5 tonne elephant. In modern world this creates a dangerous litigation risk, not to mention the risk of fatal injury.

Another concern is the growing risk of litigation from damaged bollards not quickly replaced/ unstable bollards/ trip factors/ injury to public resulting from missing bollards/ bollards loose in footing or out of alignment/ bollards becoming projectiles/ metal protrusions causing trip factors/ and disturbance to public caused by repeated repairs to damaged concrete pavements.



Awarded Innovator of the Year and Department of Occupational Health and Safety WorkSafe Award, Smart Urban has developed **a simple means of overcoming all of the “above problems”** by preserving the integrity of foundations, ensuring there are no trip factors, ensuring bollards remain secure and substantially improving turn-around times and reducing disturbance by reducing time for replacements from hours to seconds.

Containment Level

Designed for use in carparks and roadside parking zones, the containment level for Impact Recovery Bollards is a passenger vehicle (1600kg travelling at 10km/hr). In most instances a person who impacts a bollard will notice and reverse off the bollard without damage to the bollard or vehicle.

If the speed is higher than 10km/hr the driver may not have time to react, and the resistance core will bend but the core and bollard will remain secured in the footing. The damaged bollard can be replaced quickly and efficiently without disturbance.

If severely impacted by a truck or very large vehicle the bollard may come loose from the core, but this is only in extreme circumstances. Unlike hard steel bollards, a soft Advanced Polymer Bollard is will substantially reduce the risk of any resulting damage or injuries.



Is the bollard likely to have hazards before the impact (e.g. sharp components, trip factors)?

No- the bollards provide a soft outer surface with domed cap, with no protrusions or trip factors. If Impact Recovery Bollards are removed the ground socket can be capped- no trip factors.

Is the road safety barrier or device likely to have sharp or spearing elements that have the potential to cause injury after an impact? No- the soft outer casing will remain secure when a bollard is impacted, resulting in no dangerous protrusions that are likely to cause injury to public.

Is the bollard likely to obstruct a lane after an impact (e.g. including generated debris)? No, the bollard will deflect away from the road as this is the direction it will be impacted.

Locally manufactured

Our products are all locally made and manufactured using only high quality Australian raw materials. We guarantee quality and consistency of supply. Our manufacturers have stringent quality control mechanisms in place and all products are double checked and signed off on to ensure no discrepancies or deviations from the advertised product occur.



Emergency Access

Does the bollard have provision for emergency access?

Yes, bollards secured using the Impact Recovery System can be quickly and efficiently removed (and the ground socket capped) to allow access. A cap is supplied with every unit and replacement.

End of life

In 10-20 or even 50 years' time you decide to replace the bollards, Impact Recovery Bollards can be quickly and efficiently removed (re-used in another location or recycled) and replaced. Or if for some reason (we have developed an energy field that repels vehicles) and they are no longer required, the bollards can be removed, and the ground sockets capped. No damage, no disturbance and no major costs.



Environment

With more than half a million bollards and roadside items damaged every year, and predictions that we are entering a period of massive urbanisation, we urgently need to make bollards and valuable concrete foundations re-usable, now, for the first time in history, the damage and waste can be reduced to **ZERO** for the life of a development (100 years +)

100 %

REDUCE DAMAGE

100%

REDUCE WASTE

100%

REDUCE CONSUMPTION

Unbreakable Foundations

Repeated repairs to pavements and traffic island are consuming hundreds of thousands of tonnes of concrete and paving every year, costing millions and substantially reducing the lifespan of developments, now, for the first time in history, the consumption can be reduced to **ZERO** for the next 100 years.

Self-recovering, self-healing bollards

Although other devices may look the same- they are worlds apart- these advanced polymers (previously only used in the aerospace industry) are unlike metal that breaks and unlike cheap plastics that dry out, splitting and cracking, these advanced "self-healing" polymers are almost indestructible and are 100% recyclable.

Unbreakable locking device

The advanced polymers are not the only thing that sets us apart- because items are secured using only friction, there are no breakable components, which ensures bollards remain perfectly aligned, safe and secure year after year, providing a previously unattainable level of resilience and reliability, unlike anything we've seen before.

"Our actions must meet the needs of the present generation without compromising the ability of future generations to meet their own needs"



We are breaking our promise!

Did you realise cement provides one of our greatest levers against climate change?

Recognising this, every government in the world agreed to reduce emissions from the cement industry by at least 16% by 2030, yet we are breaking our promise to all of our children.

Australia remains the highest per person emitter among all large countries, sending more than 200,000 concrete footings to landfill every year and with rapid urbanisation it is about to get a whole lot worse.

We are now borrowing future resources to operate our economies in the present.

A Paris court has convicted the French state of failing to address the climate crisis and not keeping its promises to tackle greenhouse gas emissions.

"This is an historic win for climate justice. The decision should inspire people all over the world to hold their governments accountable for climate change in their courts," said Jean-François Julliard, the executive director of Greenpeace France, one of the plaintiffs.

He said the judgment would be used to push the French state to act against the climate emergency. **"No more blah blah,"** he added.

No more "blah, blah"

Design criteria

Main Roads requested a more sustainable means of securing road-side infrastructure, that would:

- Reduce time on location,
- Reduce the risk of workplace injury for roadworkers,
- Improve sustainability and resilience of foundations, reducing consumption and waste of carbon resources and disturbance to public,
- Reduce the on-going costs and risks associated with repeated replacements.

Smart Urban developed ZERO WASTE self-healing, self-locking foundations that protect paving and concrete footings for the entire lifespan of a development and enable fast efficient replacement of damaged items from a standing position, facing traffic.

City of Perth requested a means of securing bollards on ZERO WASTE Foundations that would provide a low-cost solution to the growing damage to bollards in the city centres resulting from errant vehicles. They had a long list of requirements but mainly that bollards needed to be impact resistant.

Requirements included

- Protect pedestrians from errant vehicles,
- Protect foundations from damage when bollards are impacted,
- Be easy to remove and replace,
- Reduce maintenance,
- Reduce time on location for workers,
- Reduce disturbance to underground services,
- Continue working following repeated impacts,
- Reduce heavy labour,
- Reduce waste,
- Reduce consumption of concrete.

Smart Urban delivered a sustainable solution that makes bollards impact resistant, but also removable and reusable following severe impact. They returned for a surface mount option that is now used throughout the city in Northbridge and in the



Proactive performance

Too often civil infrastructure maintenance teams are reactive rather than proactive. You react to damaged infrastructure, to lost or missing assets, to outdated assets, and impending upgrades. But what if you could do more than simply react? By implementing Sustainable Asset Management strategies, you can prevent your biggest problems.

Growing populations and increasing challenges such as traffic congestion, carbon waste and insufficient infrastructure have seen cities implementing sustainable technologies to solve their problems. But it's only when these solutions are widely implemented that a city can realise its full potential. The UK alone spend £40 billion a year on the repair and maintenance of existing, mainly concrete, structures. This contributed significantly to CO2 emissions from cement manufacturing. But what if bollards could self-recover and footings could literally self-heal?

Instead of the current cycle of never-ending damage and costly repairs, resulting in ever increasing consumption of finite resources and ever-increasing amounts of landfill - We are entering a new age of healing we now have the technology to heal our cities and prevent any future damage.

Self-healing materials were voted one of the top ten emerging technologies by the World Economic Forum. Previously this technology was only really explored by the aerospace industry, but its potential widespread use in the concrete construction industry has resulted in the development of Smart self-healing foundations that are revolutionising the road infrastructure industry.

This technology is now being used to transform static urban environments (that remain in a constant state of decay), into dynamic environments that never grow old or unsafe. Using this innovative technology, we can not only build safer, more sustainable developments but we can greatly improve workplace safety and efficiency.

Efficiency in infrastructure investment must form a central focus for Australia's governments, as they seek to close the infrastructure gap. After all, each dollar saved by eliminating cost overruns and inefficiencies can be invested into further improvements"

Minister for Transport

A resilience-based approach to infrastructure is vital so we can better adapt to change and reduce our exposure to risk. Decisions taken today, particularly those related to the redesign and retrofitting of existing infrastructure, will affect how well our network is able to adapt to change into the future. Focusing on the problem now will help avoid costly future investments and disruptions to operations."

Main Roads WA

Innovator of the Year for
developing Smart
Sustainable Foundations

Dept Commerce

Worksafe Award for
eradicating the need for
digging & heavy labour

Dept Occupational Health & Safety

Only securing device
approved for use by in all
states of Australia

Australian Road authorities

Installation IR Bollards

The system has been designed to reduce the risk of workplace injury during installation, using an installation tool to enable all work to be conducted from a standing position, facing traffic.

350 mm Depth footing is sufficient for most carpark bollards installed in asphalt. For footings installed directly in sand; free standing footings or bollards subject to severe impact, we suggest installing 650 mm depth ground socket in 700 mm concrete footing.

NB: If bollards are likely to be impacted by trucks and utility vehicles we suggest increasing the resistance core to 5mm wall thickness and using a reo cage to reinforce the footings.

Unit Includes:

- 2 x Impact Recovery Rings
- 2 x Metal Clamps
- 1 x Steel Resistance Core
- 1 x Securing stud

Footings

- Ground socket 350 Depth
- Cap

Additional sockets used to extend depth by 300 mm increments.

Tools required

- Installation Tool
- Removal Tool

Install socket

OVERVIEW: Use installation tool to position ground socket in hole and check alignment. Fill hole with concrete flush with ground level (min 30 MPa Concrete) and dress off. Spin tool to remove from ground socket. Cap off ground socket until concrete cures.



Increasing resistance

You need to find the right balance for each situation and weigh up damage to vehicles vs damage to bollards. The strength of the resistance core can be increased to 5mm to reduce the incidence of the resistance core bending and needing replacement. This will increase damage to the vehicle if it attempts to “drive through” the bollard and will reduce the incidence of bollards bending and requiring replacement.

Increase strength of footing accordingly: The footings need to be 650 mm depth and we suggest installing a reo cage to withstand the energy force acting upon the footing and ensure the concrete footing will remain sustainable and resilient to impact.

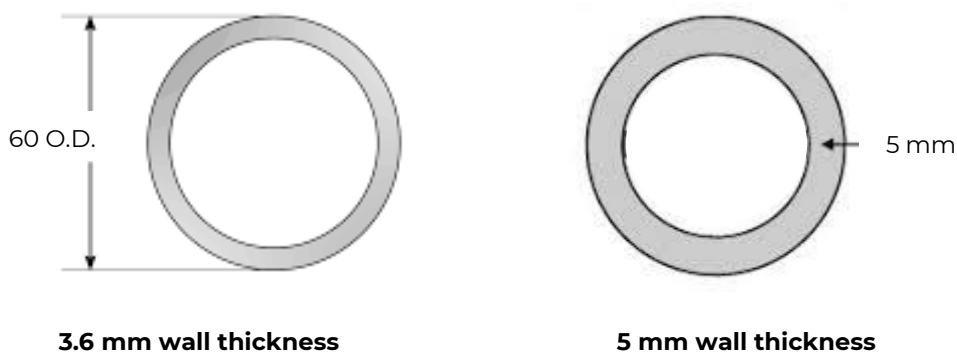

A 950 mm x 3.6 wall thickness or 5mm wall thickness replacement Resistance core is available for 650 Depth units and a 650 mm replacement core for 350 Depth units with Taper attached. (Rings not included- Impact Recovery Rings are removable and reusable withstanding hundreds and hundreds of impacts)



Reinforcing Footing

If bollards are likely to be impacted by trucks and utility vehicles, or you wish to increase the resistance against damage, or bending you can increase the resistance core to 5mm wall thickness and use a reo cage to reinforce the concrete footings.

Reo cage

If bollards are likely to be impacted by trucks and utility vehicles, you can use a reo cage to reinforce the concrete footings. The footings will be more resilient to impact. NB: Socket provides a protective shield in the concrete it does not alter the size footing or resistance against dislodgement.

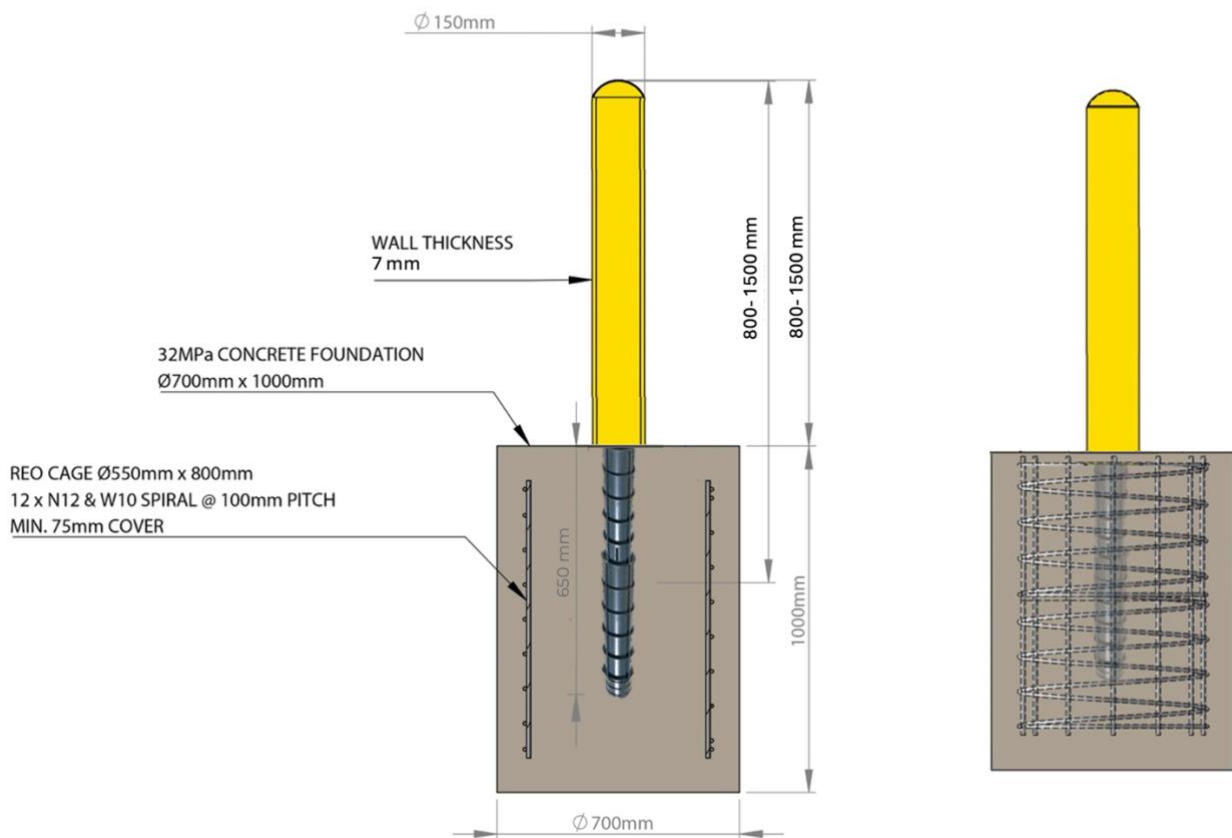

Installing ZERO WASTE foundations

ZERO WASTE Foundations can be used to install any size or weight item from signposts, to barriers, bollards, bike racks, bins, seating and street furniture.



(A) Ground Socket (B) Self-locking Taper (C) Screws (D) Cap (E) Installation Tool (F) Spirit Level

IMPORTANT

1. Ground socket must be flush with ground level
2. Rapid set is NOT impact resistant (To be impact resistant concrete must be 30 – 40 MPa or greater)
3. Concrete footing must be large enough to ensure it is not dislodged when item is impacted- refer to local guidelines as conditions differ from region to region.
4. Paving is NOT impact resistant- so you must use a min of 150 mm concrete on all sides of ground socket.
5. If you want drainage- pierce hole in base of socket (weak spot provided) and place rubble beneath socket.
6. When you remove item or tool, insert cap to prevent ingress of water, concrete and grit.

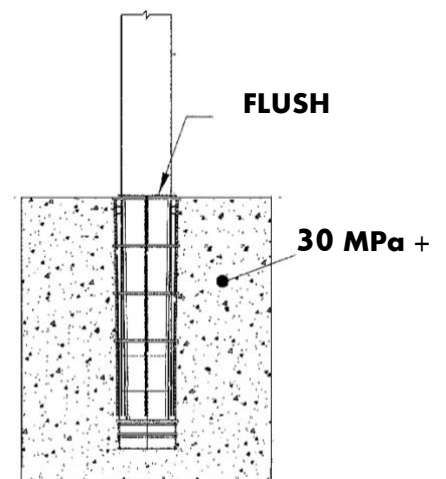

Extending ground socket

You can extend the depth of the ground socket by truncating one socket and placing firmly inside a second ground socket to extend depth by 300 mm increments.

Truncate one ground socket just below the second horizontal rib and insert truncated end firmly into the top of a complete ground socket.

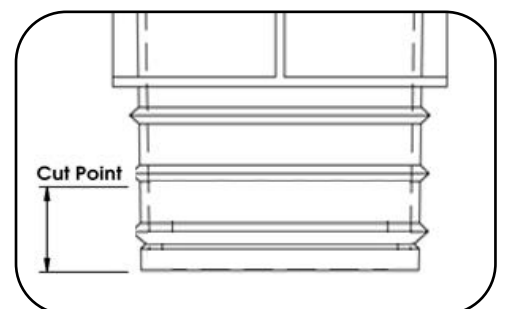

Installing ground sockets

Dig or augur hole to required depth: (if retrofitting into solid concrete core drill hole 100 mm diameter) and place rubble in base of hole to position socket upright.

- 400 mm depth x 400 mm width for 350 mm installations
- 700 mm depth and 500 mm width for 650 mm installations
- If using a reo cage allow for the size cage

Use installation tool to position socket upright in hole and check alignment. twist tool to remove and cap off until concrete cures.

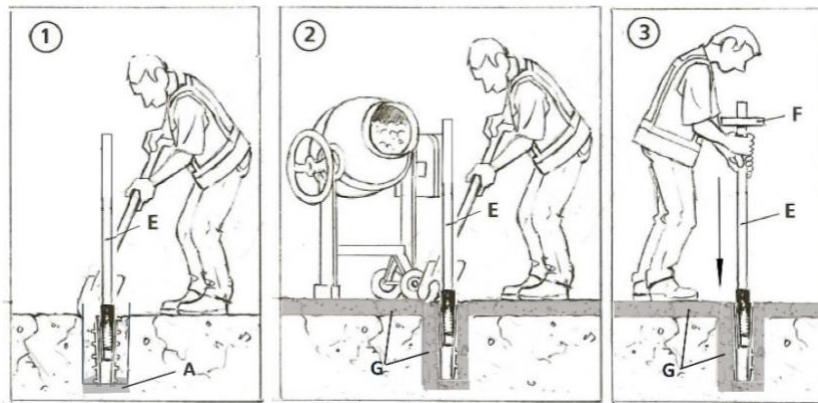

NB: Ground socket must be surrounded by a minimum of 200 mm quality 30 - 40 MPa concrete to make it impact resistant and protect the surrounding paving from damage. The footing must also be made large enough to ensure it is not dislodged (a little more concrete will ensure the footing can be reused for the next 100 years)

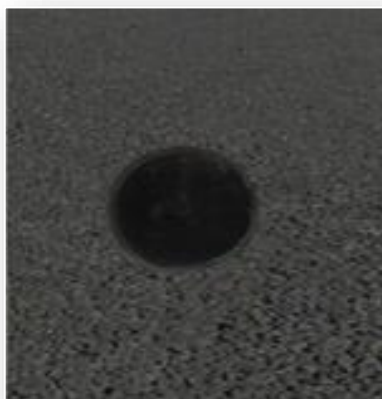

Installing Bollards

Once concrete has cured a “self-locking” taper is used to secure the resistance core in the socket. The units are supplied with the self-locking taper attached and are resistance core is simply dropped into the ground socket “automatically” locking in tight and is only removable using the tool provided.

The Impact Recovery Rings are slipped over the resistance core and attached using clamps provided (tightened using a standard flathead screwdriver) until they do not move.



ATTACH RINGS

Taper is attached to resistance core using self-drilling screws and bollard shockers using clamps provided



DROPPED INTO SOCKET

Resistance core is simply dropped into ground socket automatically locking in



INSTALL BOLLARD

Bollard is simply slipped over rings and secured by inserting securing stud beneath bottom ring.

The bollard is then slipped over the rings and secured by inserting a securing stud in a hole provided near the base of the bollard (the stud sits below the bottom ring to ensure the bollard cannot be lifted off the Impact recovery System). NB: Client has the option of standard stainless-steel securing or security studs (tightened using a standard Allen key) which require a security Allen key to install and remove.

Once installed they look like standard every day in-ground bollards remaining rigid and perfectly aligned, only removable using tools provided. They cannot be deflected by hand and will only deflect upon impact from a vehicle.

Replacing Bollards

If badly damaged the securing stud is removed, the bollard lifted off and the resistance core replaced. The bollard and the securing stud are then reinstated quickly and efficiently without disturbance.

A “self-locking” taper is used to secure the resistance core in the socket. An ergonomically designed removal tool is used to beak the seal on the self-locking taper and lever the resistance core from the ground socket. The resistance core is replaced with a new resistance core and simply dropped into the ground socket “automatically” locking in tight and is only removable using the tool provided. The bollard is then installed as usual.



REMOVE STUD

Remove securing stud from bollard using Allen key (or security Allen key)



REMOVE BOLLARD

Slip bollard off



REMOVE CORE

Lever damaged resistance core from socket using tool provided

Replacement components

The ONLY component that requires replacing following bad impact is the resistance core which can bend and need replacing. All other components (

- Concrete footings
- Self-locking Taper
- Ground socket
- Impact Recovery Rings
- Bollard

are reusable following multiple impacts.

3 Options for resistance core:

- 1) 650 mm x 3.6 mm wall thickness Resistance Core (for 350 mm foundations with 300 mm above ground)
- 2) 950 mm x 3.6 mm wall thickness Resistance Core (for 650 mm foundations with 300 mm above ground)
- 3) 950 mm x 5 mm wall thickness Heavy Duty Resistance Core (for 650 mm foundations with 300 mm above ground)

The strength of the resistance core can be increased to 5mm to reduce the incidence of the resistance core bending and needing replacement. This will increase damage to the vehicle if it attempts to "drive through" the bollard and will reduce the incidence of bollards bending and requiring replacement.

Increase strength of footing accordingly: The footings need to be 650 mm depth and we suggest installing a reo cage to withstand the energy force acting upon the footing and ensure the concrete footing will remain sustainable and resilient to impact.

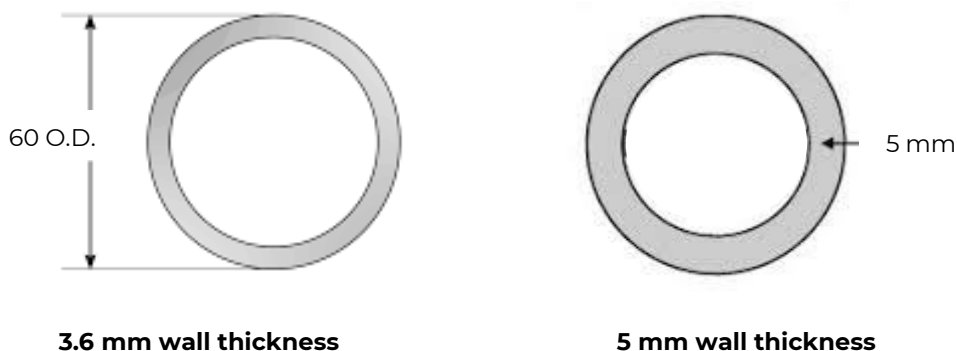

Tasks

Hazards

Safe working procedures

Precautions

Installing Sockets	<ul style="list-style-type: none">- Bending of the back- Twisting of the back- Working in traffic	<ul style="list-style-type: none">• Dial before you dig• Install appropriate traffic management• Dig hole to insert ground socket• Insert Installation tool inside ground socket• Lower installation tool & socket into hole and fill with concrete.• Operate installation tool from standing position with straight back• Once concrete has cured spin tool to remove• Safely dispose of waste (recycle if possible)	<ul style="list-style-type: none">- Use installation tool to avoid bending of the back- When possible, it is advisable for user to face on-coming traffic- If item is not ready to install- insert cap to avoid tripping factors/ entry of dirt and grit- Insert cap before pouring asphalt to avoid trip factors/ ingress of asphalt
Installing Items	<ul style="list-style-type: none">- Bending of the back- Twisting of the back- Working in traffic- Item not secure	<ul style="list-style-type: none">• Install appropriate traffic management• Attach Taper to item using self-drilling screws provided (This can be done prior to going onsite to reduce time on location)• Using two hands, drop item firmly into ground socket• Check item is sufficiently installed to protect from unauthorized removal	<ul style="list-style-type: none">- Avoid bending of the back- Avoid twisting of the back- When possible, it is advisable for user to face on-coming traffic- Make sure taper finishes flush with round level to provide adequate resistance against unauthorized removal
Using Removal Tool	<ul style="list-style-type: none">- Bending of the back- Twisting of the back- Working in traffic- Trapping of fingers	<ul style="list-style-type: none">• Position a minimum of two safety cones or safety barriers at extremity of working space• Make sure the base of the tool as close as possible to the base of the item before applying jerking action• Apply quick jerking action using both arms• Lift item from ground socket using two arms (for items over 25 kg 2 people must lift item from ground socket)• Bend knees to insert cap in ground socket/ or insert new item	<ul style="list-style-type: none">- Always operate tool from a standing position facing tool- Keep back straight- Use quick jerking action as it requires less force- When carrying tool hold arms together with upright to avoid trapping fingers- When possible, it is advisable for user to face on-coming traffic

Impact/ Energy Absorbing Bollards

Impact Absorbing Bollard, were crash tested in accordance with AS/NZS 3845.2 demonstrating crash worthiness for speed zones up to and including **60 km/hr**

Bollard:

150 mm diameter Steel
1450 mm Length
Weight 67.5 kg

Footing:

Installed in solid asphalt.
700 mm width concrete footing
1000 mm below ground
Reinforced using reo cage

Vehicle

Passenger vehicle weighing 1600kg.
Impact Speed 60km/hr

OPTIONS

By increasing the depth of the footing with a reinforcing reo cage bollards can control errant vehicles weighing up to 2270ka



Outcome: Bollards deflected to a maximum of 60 degrees upon impact demonstrating they were capable of preventing an errant vehicle from entering an area. The impact absorbing cushion crushed and required replacing.

The “impact absorbing” nature of the bollards results in vehicles being brought to a complete stop, protecting people and assets from errant vehicles

[VIEW VIDEO](#)



Impact/ Energy Absorbing Bollards

Meets Australian Crash Barrier Standard AS/NZS 3845:1999 (60 km/h).

Dimension: Dia. 150 mm x 1450 mm

Weight: (kg) 67.5

Speed (km/h): Used for roads 60 kph

Colour: Standard Colour Safety yellow

Finish: Galvanised (F1202002) or Painted

(F1202003) Height: 1000mm above ground

Cartridge: 355.6 mm Top and 165 mm Bottom x

800 mm Weight: 28.5 KG



Fully crash tested

- Provide protection for drivers and pedestrians
- Prevent vehicles from entering an area
- Reduce the risk of injury to the driver and vehicle occupants
- Easily replaced post impact

Designed to absorb energy during a collision, Energy absorbing bollards are capable of absorbing kinetic energy during a collision. By absorbing the impact, these bollards minimise injury to the driver and passengers whilst effectively preventing entry into an area.

Two Options

- Ultra, fully crash tested with a 1600kg vehicle at 60km/h.
- Super Duty, fully crash tested with a 2270kg vehicle at 50km/h.



Specs

The EAB is designed to a TL-0 containment level, meaning it is capable of halting vehicles weighing 1600kg while travelling speeds of up to 60 kilometers an hour. The EAB Cartridge is filled with VVH Grade Polystyrene foam which increases its shock absorbing capabilities, making it compliant with AS/NZS 1698:2006.

The EAB is one metre tall and is installed in a sub-surface mounted fashion. This product is available in a galvanised steel and powder coated finish.

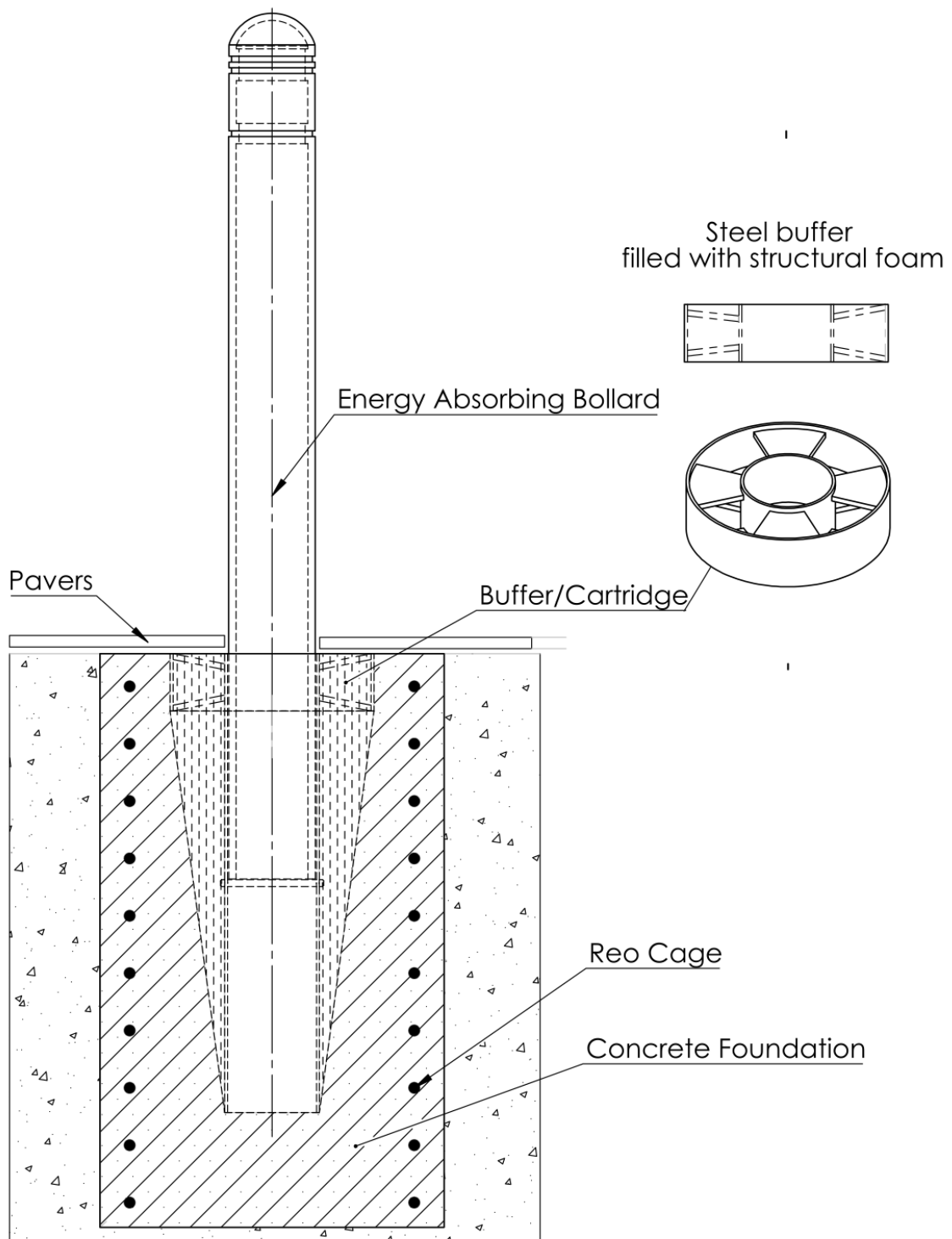

Repair and maintenance

In the event of impact, the bollard and surrounding foundations will show signs of damage and the impact absorbing cartridge will need replacing. (Damage to the cartridge will result in the above-the-ground bollard not being straight.)



- 1) The bollard is removed from the cartridge.
- 2) The concrete footing needs to be broken using a jack hammer and crowbar.
- 3) The damaged concrete footing must be removed and disposed of
- 4) A new footing and a new cartridge, and Reo cage must be installed and filled with 30-40MPa concrete to repair the damaged footing.

“Efficiency in infrastructure investment must form a central focus for Australia’s governments, as they seek to close the infrastructure gap. After all, each dollar saved by eliminating cost overruns and inefficiencies can be invested into further improvements”

Minister for Transport

A resilience-based approach to infrastructure is vital so we can better adapt to change and reduce our exposure to risk. Decisions taken today, particularly those related to the redesign and retrofitting of existing infrastructure, will affect how well our network is able to adapt to change into the future. Focusing on the problem now will help avoid costly future investments and disruptions to operations.”

Main Roads WA

**There are
only two
options:
Make
progress
or make
excuses.**